



Made in USA



LUMIRON

LED LIGHTING

“ DMR 3005 WM ONE ZONE WIRELESS DIMMER RECEIVER ”

20725 NE. 16 AVE. #A-33
MIAMI, FLORIDA 33179

Tel: (305) 652-2599

Fax: (305) 650-8812

www.lumiron.com

Email: sales@lumiron.com

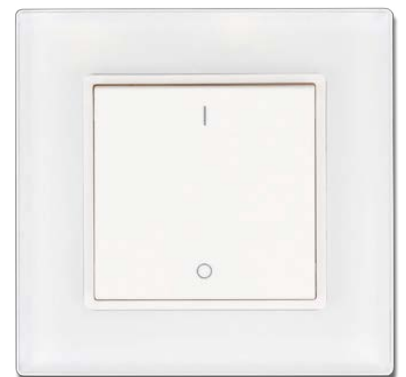

Benefits and Features

DMR 3005 WM ONE ZONE WIRELESS DIMMER RECEIVER has been designed to bring light control easily. No wires or switch box locations are needed, just stick or mount the DMR 3005 to any flat location such as walls or cabinets. The simple modern design and elegant Ivory White surface compliments a variety of LED projects. The dimmer switch features smooth and accurate dimming from 0.1%-100% without any flickering. It can also control up to four single color LED fixtures at once, for LED lights at either 12V or 24V DC. After the installation is complete, you can change the brightness from 0% to 100% brightness. The DMR 3005 Dimmer runs on a single internal 3V battery (included) and includes a receiver. The wireless design saves time and energy by requiring no cabling or installation to pair the DMR 3005 Dimmer with the LED zone. The DMR 3005 Dimmer is easy to install and operate, and will provide many years of easy operation.

Main Functions

- No Wires, Stick or Mount to Any Flat Surface.
- Full Dimming Control.
- 50 Foot Wireless Range.
- Soft Touch On/Off.
- Memory Function - Remembers Last Setting Even If Power Goes Off.

Specifications

Wireless RF Remote

Part No.	Operation Voltage	Operation Frequency	Dimensions (mm)	Remarks
DMR 3005	3V	434 MHz / 868 MHz	86 X 86 X 14	Load 1 CR2430 (3V) Battery

Receiver

Part No.	Input Voltage	Current	Output	Type
RCV 600 – RF – 1000	12 – 36 VDC	4 X 8 AMP	12 Volt – 4 X 96W	Constant Voltage
			24 Volt – 4 X 192W	
			36 Volt – 4 X 288W	

Amplifier

Part No.	Input Voltage	Current	Output	Type
AMP 650 - 1100	12 – 36 VDC	4 X 8 AMP	12 Volt – 4 X 96W	Constant Voltage
			24 Volt – 4 X 192W	
			36 Volt – 4 X 288W	

Setting up the Dimming System

• Installation

The DMR 3005 WM ONE ZONE WIRELESS DIMMER RECEIVER can control up to four single color LED fixtures at once, for LED lights at either 12V or 24V DC. After the installation is complete, you can change the brightness from 0% to 100% brightness.

• Tools Required

- Philips Screwdriver.
- Flat Head Screwdriver.
- Wire Stripper.

This section will show you how to complete the wiring with a single receiver, which will connect the power supply for up to four LED fixtures. Only one LED fixture is required per receiver.



1. Remove the white plastic end caps on both ends of the receiver using the Philips screwdriver. This will expose the green wiring slot blocks.



2. To add power to the receiver, first make sure the power supply uses the correct voltage (12-24V DC). Then make sure the power supply is not plugged in. Take the negative wire coming from the power supply, and using the Wire Stripper, strip off approximately 1/4" of cover from the end of the wire. Twist the exposed metal wire to help make a secure connection.

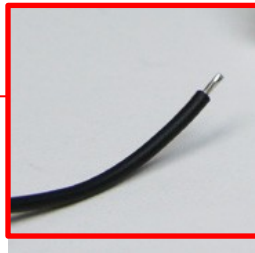

3. On the left green wiring slot block for the power supply, use the Philips Screwdriver to rotate the negative wiring screw counter clockwise to open the wiring slot located below the screw. The screw will not come out.



- Take the negative wire and insert the exposed metal end into the negative wiring slot located below the screw. Place the wire inside until the wire stops against the wall inside the negative wiring slot. Take the Philips Screwdriver and turn the negative wiring screw clockwise until the screw is snug. The negative wire has now been secured to the receiver and should not come out. If it does come out, repeat from step two, and place the exposed metal wire further into the negative wiring slot.



- Repeat steps two through four for the positive wire from the power supply. The positive wire will go into the positive wiring slot.

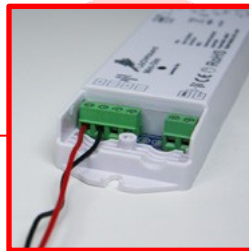

- On the right side of the receiver, connect the first LED fixture. First, take the negative wire, and repeat steps two through four above, but connect the wiring in the right side green wiring block using the negative wiring slot. Repeat again for the positive wire but using the positive wiring slot.

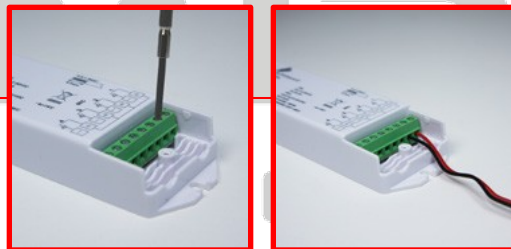

- At this time, you can attach another LED fixture by repeating step six using the right side green wiring blocks. Only one LED fixture is required to run the lights.

- The wiring for the receiver is now complete. Place the white receiver end caps back on the receiver and screw them down securely using the Philips Screwdriver.



- Plug in the power supply to the wall outlet. The LED fixture will turn on automatically. The unit is now ready to pair with the DMR 3005 WM ONE ZONE WIRELESS DIMMER.



• DMR 3005 WM ONE ZONE WIRELESS DIMMER Components

The DMR 3005 WM ONE ZONE WIRELESS DIMMER consists of the following components:

- Main Case.
- Center Button and Battery Holder.
- Double Sided Tape.
- Battery Door.
- Rear Mounting Plate.
- Battery.
- Two Mounting Screws.

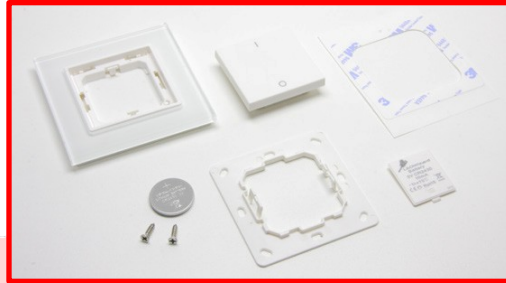

• Installing the Battery

This section will show you how to install the provided battery into the DMR 3005 WM ONE ZONE WIRELESS DIMMER.

1. Flip the DMR 3005 WM ONE ZONE WIRELESS DIMMER over to show the battery door on the back. At the base of the door pushes upwards as indicated on the door.

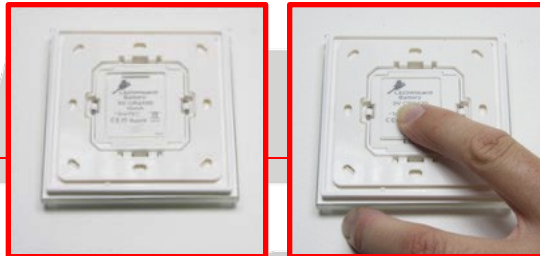

2. Then at the top of door, carefully insert your nail to lift the door from the top. The door will lift off from the dimmer. Please note on the backside of the door, the "positive" symbol is shown - this indicates that the positive side of the battery needs to face upwards.

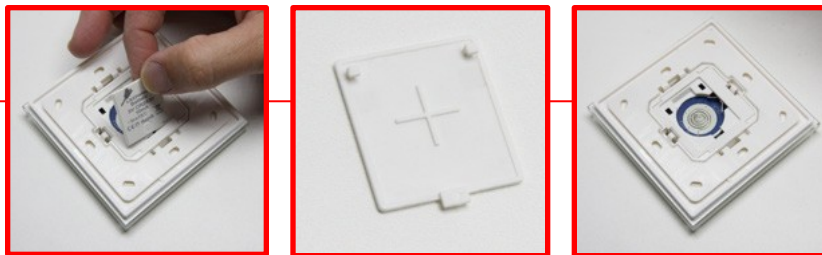

3. Take the provided battery and place it into the dimmer with the writing on the battery facing upwards. Slide the battery in with the right side first so it connects with the terminals. Otherwise the battery will not seat properly.



4. Hold down the battery with one finger as it will not stay put. Using your other hand, take the battery door and reinstall by placing it on the battery, then sliding the door backwards to lock the battery and door into place. The DMR 3005 WM ONE ZONE WIRELESS DIMMER is now ready to mount.

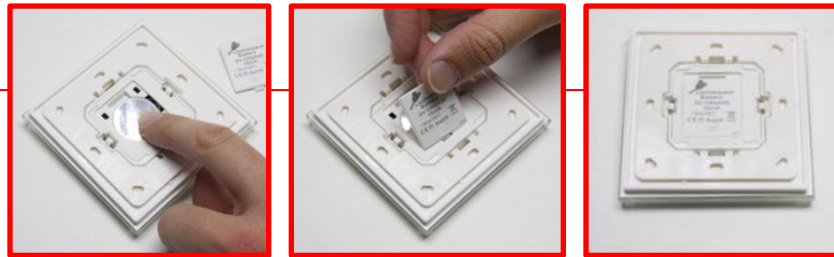

• Mounting the DMR 3005 WM ONE ZONE WIRELESS DIMMER

This section will show you how to mount the Dimmer. There are two options:

- 1) Use the provided double sided tape.
- 2) Use the provided screws.

Mounting Option 1: Double Sided Tape

1. To mount the DMR 3005 WM ONE ZONE WIRELESS DIMMER using the double sided tape, first make sure the mounting surface is clean and dry. Also check that the surface is not loose or peeling.
2. Begin by taking the provided double sided tape, and peel off the white backing paper to expose one of the sticky sides.

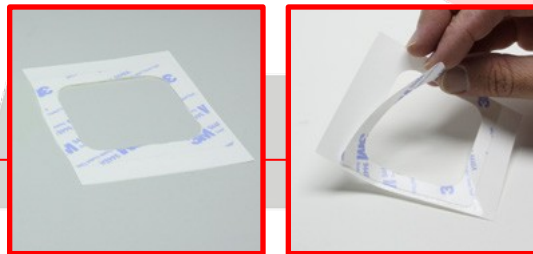

3. Take the tape and carefully attach the sticky side to the back of the DMR 3005 WM ONE ZONE WIRELESS DIMMER on the rear mounting plate. After the tape is attached to the Dimmer, push down on the tape with your fingers to make sure the tape is tightly secure to the rear mounting plate. Then carefully peel the last backing paper piece off the double sided tape from the back of the Dimmer.



4. Last, hold the dimmer up to the mounting location and make sure the buttons match the correct orientation ("on" button at the top, and "off" button on the bottom). Optionally, you can take a level and square it to the wall as you mount the DMR 3005 WM ONE ZONE WIRELESS DIMMER. Now push the dimmer firmly into place. Carefully let go while checking that the Dimmer is staying in place.

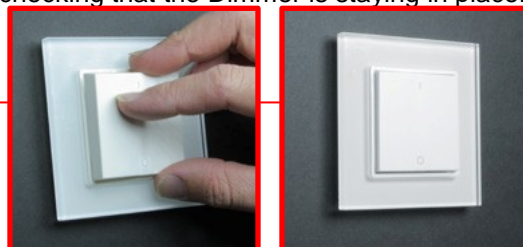

Mounting Option 2: Hard Mount with Screws

1. To mount the DMR 3005 WM ONE ZONE WIRELESS DIMMER using the provided screws, begin by placing the Dimmer face up in your hand. Push on the battery door in the center of the dimmer and the center button and battery holder assembly will release. Place the center assembly to the side.

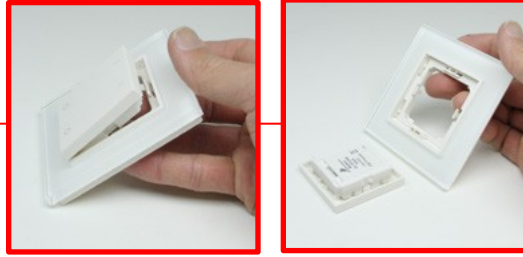

2. The clips for the rear mounting plate need to be released. The clips for the rear mounting plate are held in the top center and bottom center of the main unit. Begin by releasing the top clip by pushing up and then back. Then on the bottom clip, push down and back. The rear mounting plate should release from the main unit.



3. Take the rear mounting plate and hold it up to the desired mounting location. Make sure the clips are on the top and bottom (not side to side) so the Dimmer stays oriented correctly on the wall. The screws also go in the top center and bottom center holes.

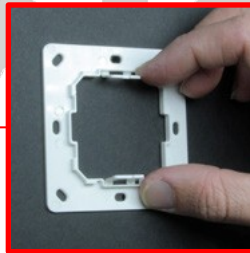

4. At this time, you can set rear mounting plate "square" to the wall using a level, and a pencil to mark the top center and bottom center holes. After the exact location is chosen, take one screw and place it in one of the holes in the rear mounting plate. Using a Philips screwdriver, tighten this screw down several turns.

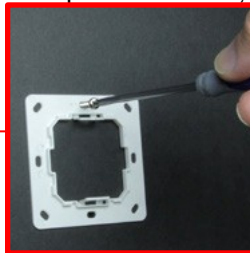

5. Take the second screw and place it in another hole across from the first screw. Take the Philips screwdriver and tighten the screw down several times. Then tighten the first screw down until it is snug. Then tighten the second screw down until it is snug. The rear mounting plate should now be snug against the mounted surface. Check that it is not loose.

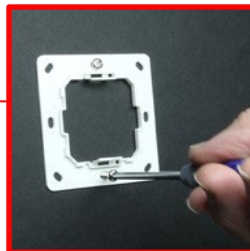

6. Next, take the main unit and place it back on the rear mounting plate, carefully push it on so the clips engage on the top and bottom. The clips will click once in place.

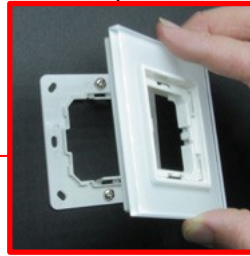

7. The center assembly is now ready to go back into the main unit. Place the center assembly into the main unit (button facing out) being careful to align the clips and the slots on the center assembly. Once in, the center assembly will gently click into place in the top and bottom. The DMR 3005 WM ONE ZONE WIRELESS DIMMER is now ready to pair with the receiver.

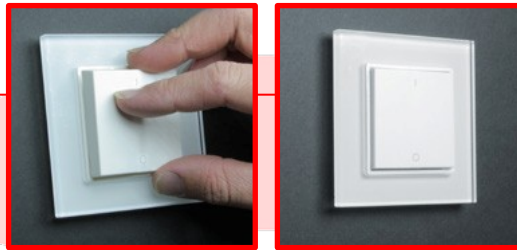

Pairing the Dimmer and Receiver

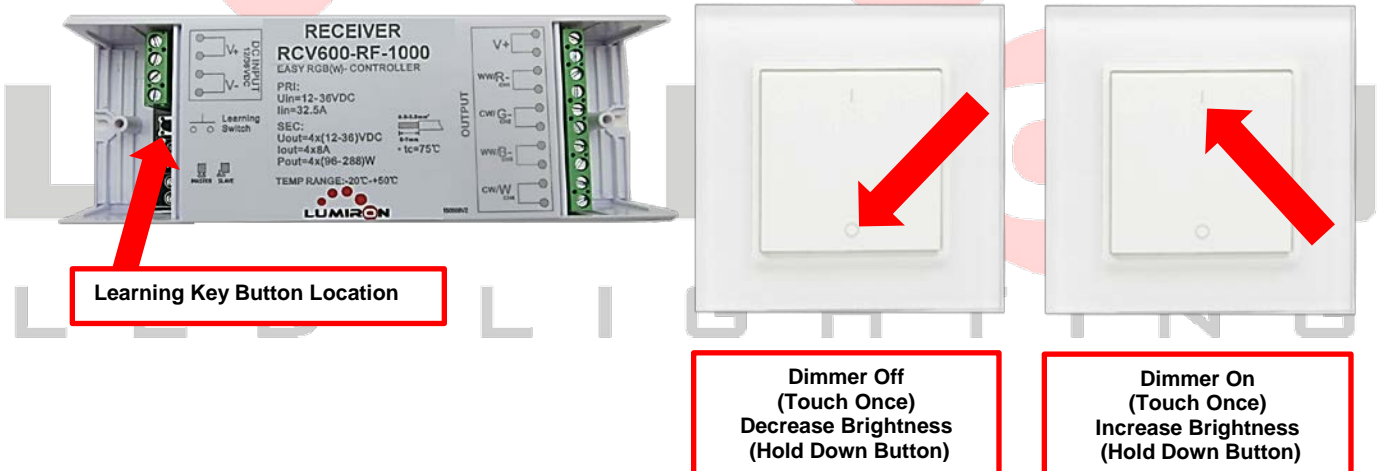

- Make sure the LED(s) and power supply are turned on and correctly connected. On the receiver, push the Learning Key button once. On the Dimmer, push the on and off button repeatedly until the lights on the LED(s) flash. The flash indicates that the receiver and the dimmer are paired. This should happen within the first five seconds. The DMR 3005 WM ONE ZONE WIRELESS DIMMER is now ready to work.

Safety & Warnings

- The product shall be installed and serviced by a qualified person.
- IP20. Please avoid the sun and rain. When installed outdoors, please ensure it is mounted in a water proof enclosure.
- Always be sure to mount this unit in an area with proper ventilation to avoid overheating.
- Please check if the output voltages of any LED power supplies used comply with the working voltage of the product.
- Never connect any cables while power is on and always assure correct connections to avoid short circuits before switching on.
- Please ensure that the cable is secured tightly in the connector.
- For update information please consults your supplier.

Operating the Dimmer and Receiver

1. To turn the lights on, push the top left “on” button once. To turn the lights off, push the bottom left “off” button once.

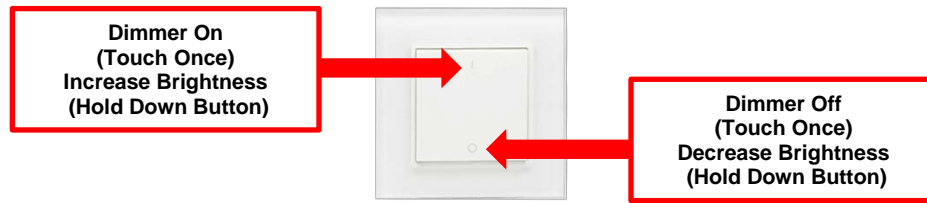

2. To decrease the brightness, push and hold the bottom “off” button and watch the lights. When the lights dim to the selected level, let go of the button. To increase the brightness, push and hold the top “on” button and watch the lights. When the lights brighten to the selected level, let go of the button.

Troubleshooting

This section will show you how to troubleshoot the DMR 3005 WM ONE ZONE WIRELESS DIMMER.

1. If you are having problems with the lights responding to the Dimmer, first check that the dimmer is within range of the receiver (50 feet maximum).
2. Check that the lights are “on” and the wiring to and from the Receiver match the diagram. Check that the wiring to the Dimmer matches the wiring diagram.
3. If there is power going to the receiver and the lights do not shine when turned “off” and “on”, the Dimmer could be dimming the lights. Press and hold the on button until the lights brighten, then let go of the button when the lights have reached the desired level of brightness.
4. You can re-pair the DMR 3005 WM ONE ZONE WIRELESS DIMMER and the receiver by following these steps:
 1. On the receiver, hold the Learning Key button down for 10 seconds. This will reset the system to its default setting.
 2. Push the Learning Key button once, and then touch the “on” button then the “off” button quickly several times until the lights blink. The dimmer and receiver for the selected zone are now paired.

• Battery Replacement

The DMR 3005 WM ONE ZONE WIRELESS DIMMER uses one CR2430 Battery. If you have tried the previous steps and the controls on the Dimmer are not working, the battery could require replacement.

1. First, remove the button and center assembly. Push down on the bottom of the button, and then pull at the top of the button. The button and center assembly will loosen and pull straight out. If a button comes out, they are easy to snap back into place, just align the button on the center assembly and carefully snap the button back into place.

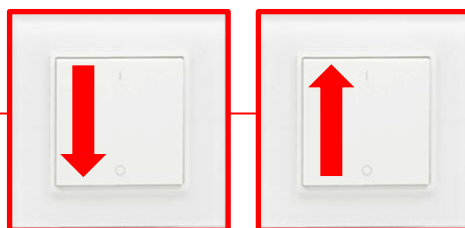

- Then flip over the center assembly to reveal the battery door. Push the battery door up and then lift it off. Replace the battery with another CR2430 battery making note of the orientation of + and -, the + side needs to face out from the center assembly. Place the battery door back into the center assembly and slide the door down until it clicks into place.

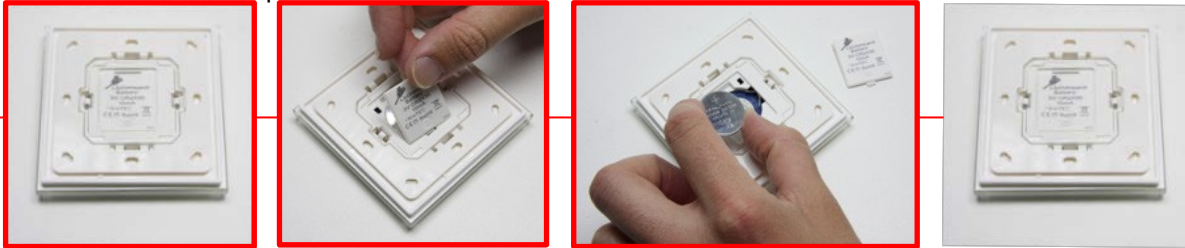

- Take the center assembly with button and place it back into the Dimmer main assembly, making sure the orientation of the button is the same. The center assembly will click into place. If the center assembly does not click into place and is loose on the wall, the side tabs for the center assembly could have been pushed against the wall. Remove the center assembly using the same method in step A, and push the side tabs to the side, to ensure they grab and hold the center assembly. Re-insert the center assembly making sure the orientation is the same as before.

AMP 650 – 1100 Pictures



Wiring Diagram

1) Receiver Connection Diagram for Single Unit

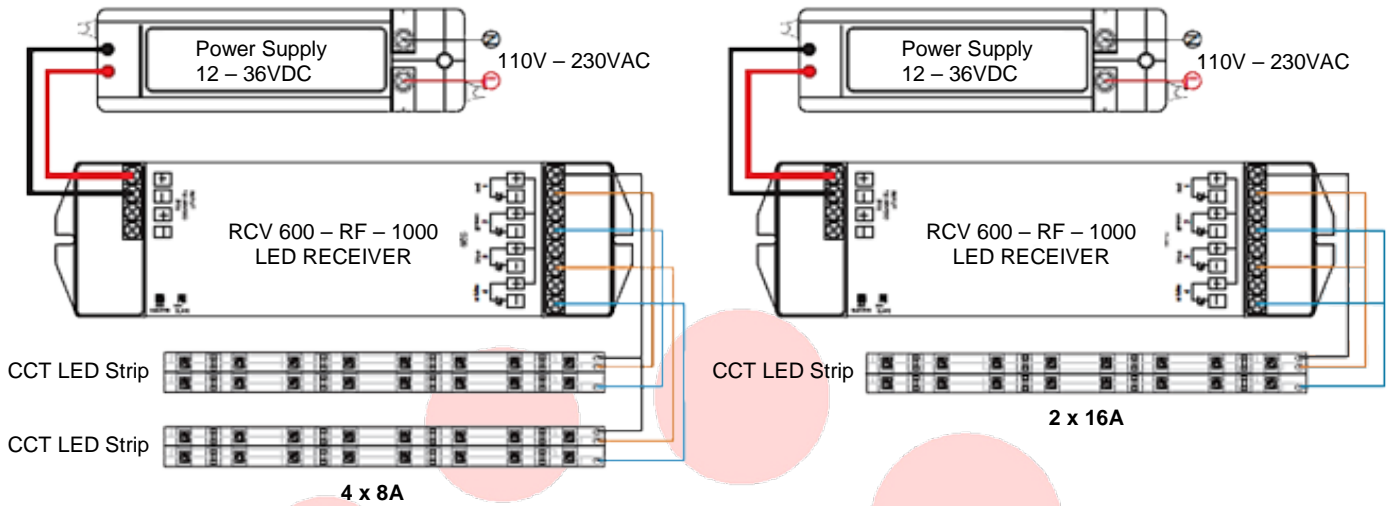

2) Receiver Connection Diagram for Multiple Units

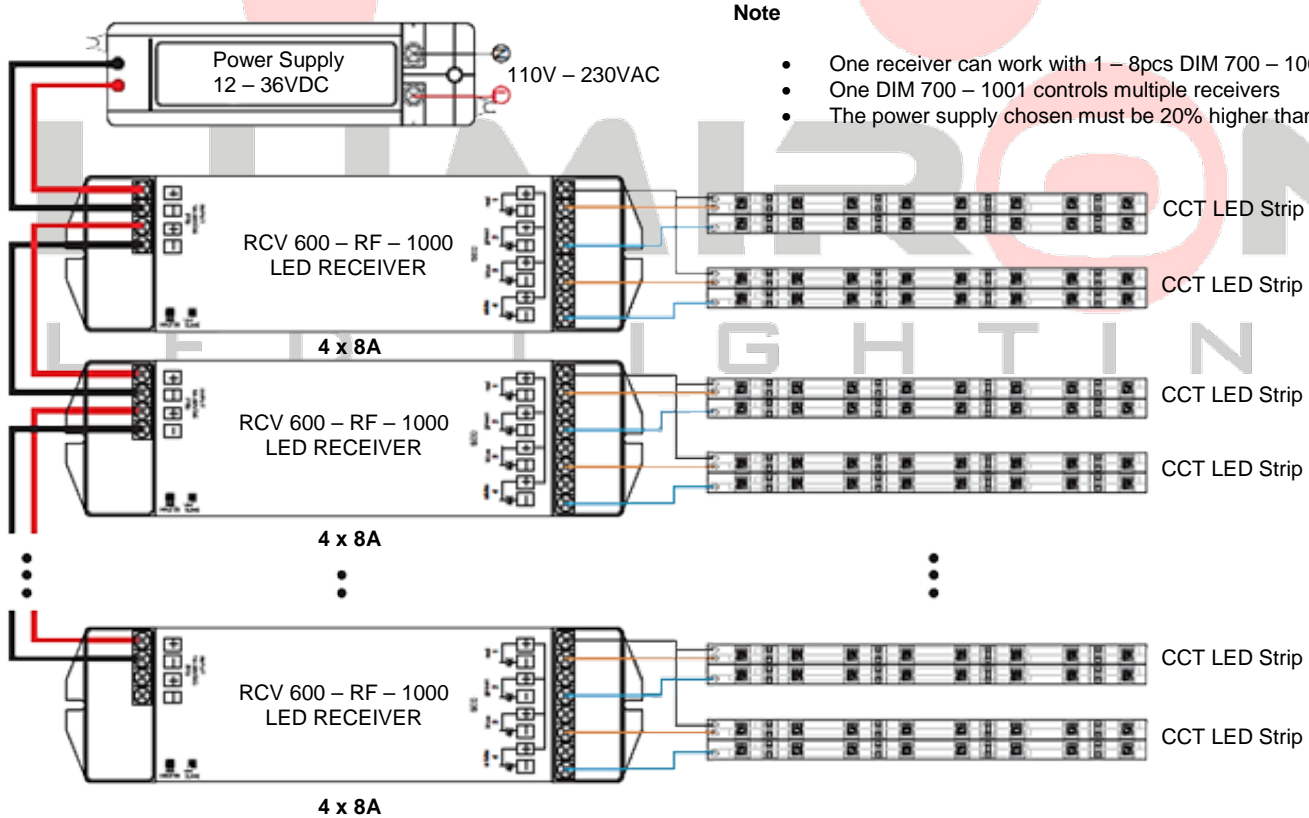

Note

- One receiver can work with 1 – 8pcs DIM 700 – 1001
- One DIM 700 – 1001 controls multiple receivers
- The power supply chosen must be 20% higher than the actual load