



[lumiron.com](http://lumiron.com)

**LUMIRON**  
LED LIGHTING

# CASPER

## SINGLE COLOR

### FLEXIBLE LED SHEETS

## PRODUCT SPECS

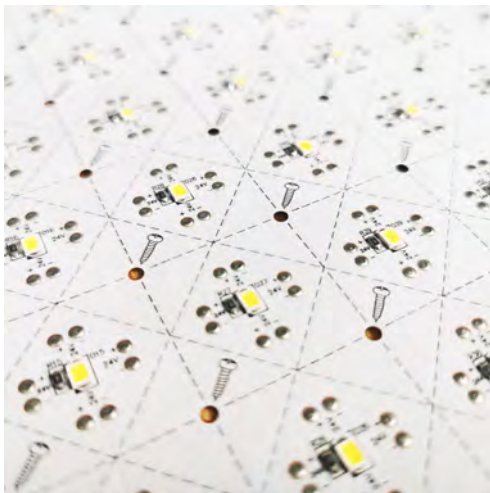

# WELCOME

**CASPER LED FLEXIBLE SHEET** Single Color White is the most advanced light sheet ever created. It features revolutionary improvements over the original initially produced.

**PART No. CAS-288-XX-24V-IXI**

## HIGHLIGHTS

- Single color white temperatures
- Cuttable down to a single LED or LED group while maintaining UL Listing
- Easy installs with plug-in-play light sheet connections
- Patented design exemplifies ingenuity and advantage
- Five year warranty

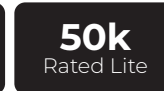

## ELECTRICAL

INPUT VOLTAGE	24VDC - Constant Voltage
POWER CONSUMPTION	20 W Per Sheet (10W / ft <sup>2</sup> , 93.W/m <sup>2</sup> 0.14W per LED)
WIRES	20AWG 2 wire (black wire + white wire -)
CERTIFICATIONS	UL Listed (E363518) CE Compliant (EMC and LVD) RoHS Certified

## PHYSICAL

COLOR TEMPERATURE	5300 K
CRI	90
LIGHT OUTPUT	2000 Lumens per sheet
MOUNTING	Mounting holes, Adhesive backing as a supplementary method
OPERATING / WORKING TEMPERATURE	<b>Operating:</b> -22°F to 122°F (-30°C to 50°C) <b>Working:</b> 93°F (34°C)
SURFACE TEMPERATURE	<b>LED:</b> -97°F (36°C to 50°C) <b>PCB:</b> 90°F (32°C) <b>Resistor:</b> 93°F (34°C)
ENVIRONMENT	IP20 - Dry locations only
COVERAGE	2ft <sup>2</sup> (0.19m <sup>2</sup> ) per sheet / up to 10 ft <sup>2</sup> (0.93m <sup>2</sup> ) per Class 2 guidelines
CUT / FOLD LINE SPACING	0.70" (1.8cm) short axis / 0.70" (1.8cm) long axis
DIMENSIONS	12" x 24" (15cm x 60cm)
WEIGHT	0.4lbs / 6.32oz / 179g

## FEATURES

<b>FIELD CUSTOMIZABLE</b>	Maintains UL Listing when cut
<b>ENERGY EFFICIENCY</b>	100 lumens per watt
<b>LONG LIFESPAN</b>	50,000 + hours
<b>FLEXIBLE / FOLDABLE PCB</b>	Polyimide film substrate
<b>CONSISTENT LIGHT QUALITY</b>	Tight ANSI bin control LEDs
<b>LED QUANTITY / DENSITY</b>	288 SMD type 2835 LEDs per sheet
<b>FULL INTEGRATION SUPPORT</b>	From concept to completion
<b>UNIQUE POWER DISTRIBUTION GRID</b>	Groups or single LEDs can be cut from anywhere on light sheet
<b>WARRANTY</b>	5 years Limited Warranty

## POWER & CONTROLS

Compatible with all control protocols via associated power and control components. Quality tested for low-end light output consistency across all LEDs (100-0%).

## CLASS 2 & UL COMPLIANCE

Use Class 2 power supplies with a maximum power output of 96W (per channel/circuit) to retain UL Class 2 Listing compliance. Best practices include allowing headroom for power supply longevity.

TECHNICAL DRAWINGS (not to scale)

CASPER FLEX LED SHEET

TOP VIEW

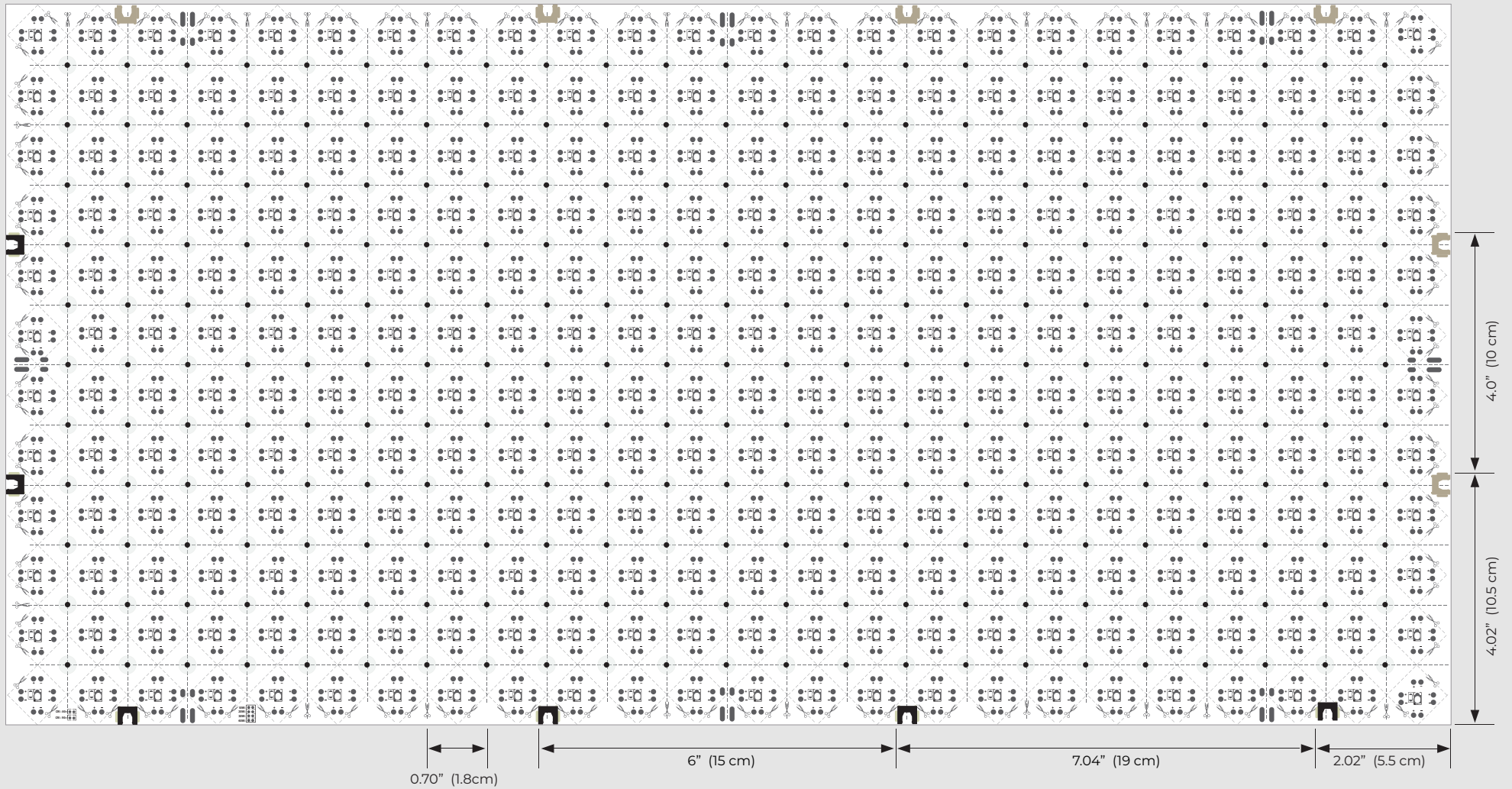

**FLEX SHEET & LED HEIGHT (SKU: CAS-288-XX-24V-IXI)**

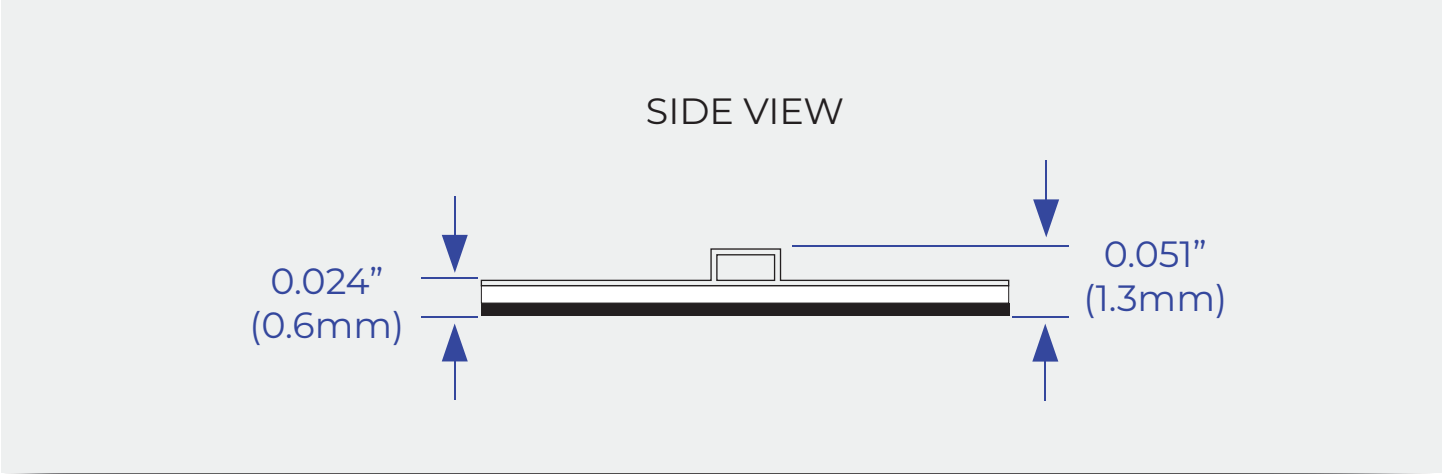

**TERMINAL PLUG**

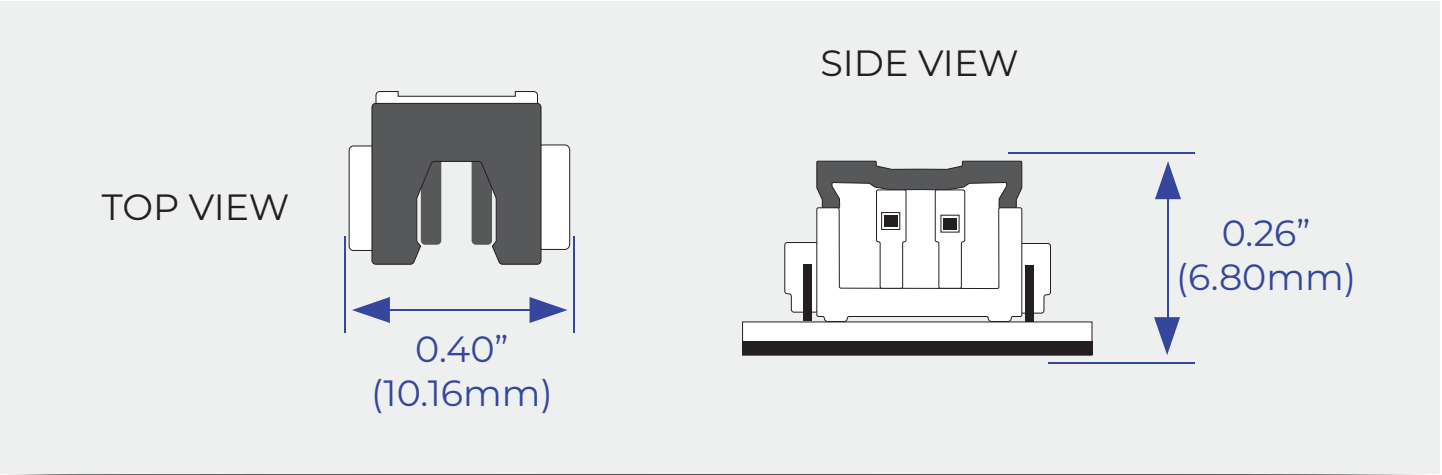

**TECHNICAL DRAWINGS** (not to scale)  
ACCESSORY PACK **(SOLD SEPARATELY)**

**CASPER Single Color** Connecting Cable 3" (SKU: **3500-CAS-350-1005**)

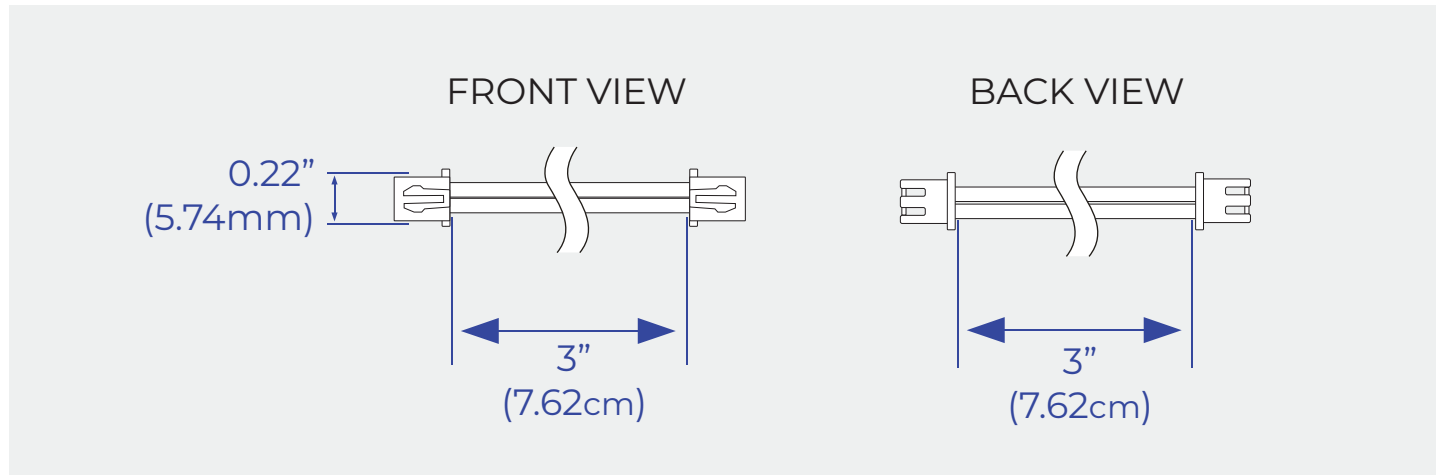

**CASPER Single Color** Connecting Cable 12" (SKU: **3500-CAS-350-100**)

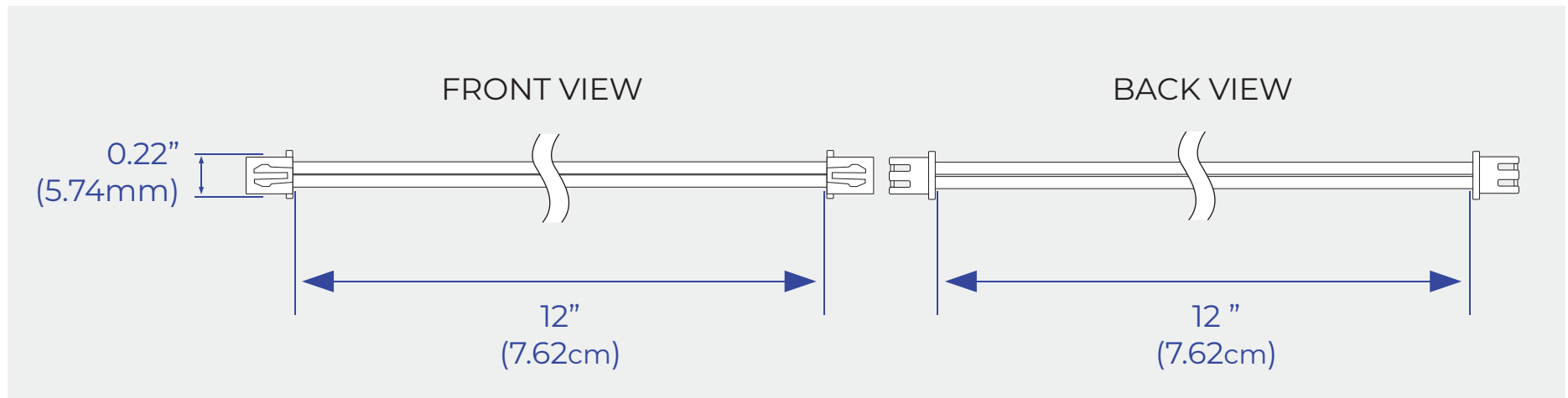

**TECHNICAL DRAWINGS** (not to scale)  
ACCESSORY PACK **(SOLD SEPARATELY)**

**CASPER Single Color Power Cord 12"** (SKU: **3500-CAS-350-1001**)

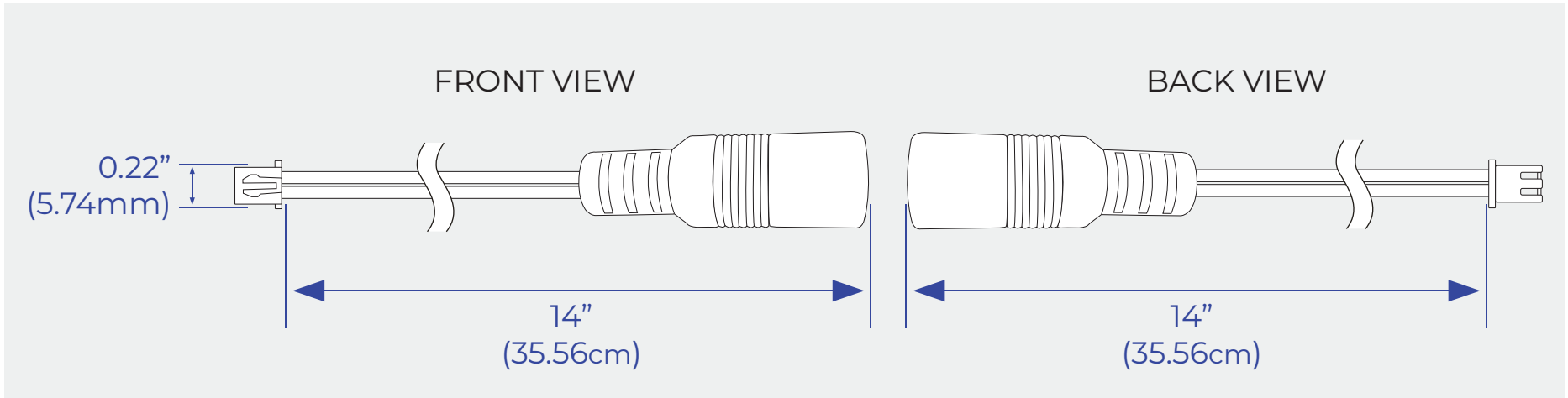

**STANDOFF Acrylic Spacers**





## BASIC SINGLE COLOR WHITE LED SHEET

MODEL	VOLTAGE	COLOR TEMPERATURE	SHEET SIZE
CAS-288-XX-24V-IXI	24 - 24VDC Constant Voltage	5300K	1224 - 12" x 24"

EXAMPLE PART NUMBER

CAS-288	—	24	—	53	—	1224
Model		Voltage		Color Temp		Sheet Size

## ACCESSORIES (SOLD SEPARATELY)

ITEM	PART NUMBER	DESCRIPTION
CASPER Single Color Connecting Cable 3" <b>(Required)</b>	3500-CAS-350-1005	0.1 lbs ( 0.05 kg ) 3 x 0.5 x 0.5 in ( 76.2 x 12.7 x 12.7 mm )
CASPER Single Color Power Cord 12"	3500-CAS-350-1007	0.1 lbs ( 0.05 kg ) 12 x 0.5 x 0.5 in ( 304.8 x 12.7 x 12.7 mm )
CASPER Single Color Connecting Cable 12"	3500-CAS-350-1004	0.1 lbs ( 0.05 kg ) 12 x 0.5 x 0.5 in ( 304.8 x 12.7 x 12.7 mm )
STANDOFF Acrylic Spacers	SPC 143R / SPC 123R SPC 98R / SPC 92RS SPC 67RS	Made of acrylic material to ensure durability and reliability, wear resistance, corrosion resistance and rust resistance..
Dimmable Power Supply Magnetic MLV 100W 24V	PSD-100W-24V	<ul style="list-style-type: none"> <li>•Power Supply Magnetic MLV 100W 24V with any LV magnetic dimmer as long as you cover dimmer's min load.</li> <li>•Temperature class B(130°C).</li> <li>•Input leads are 18AWG 600V.</li> <li>•Output leads are 18AWG 300V.</li> <li>•Leads max. operational temperature is 105°C.</li> <li>•Thermal self reset primary breaker 200A.</li> <li>•Thermal self reset secondary breaker 400A.</li> </ul>



**LEADING THE WAY ON STYLISH LIGHTNING**



---

**THANK YOU**

 [sales@lumiron.com](mailto:sales@lumiron.com)

 305-652-2599  
786-248-3918

 20725 NE 16 Ave.  
Suite A-33 Miami, FL 33179

